

WN 055568
05/01

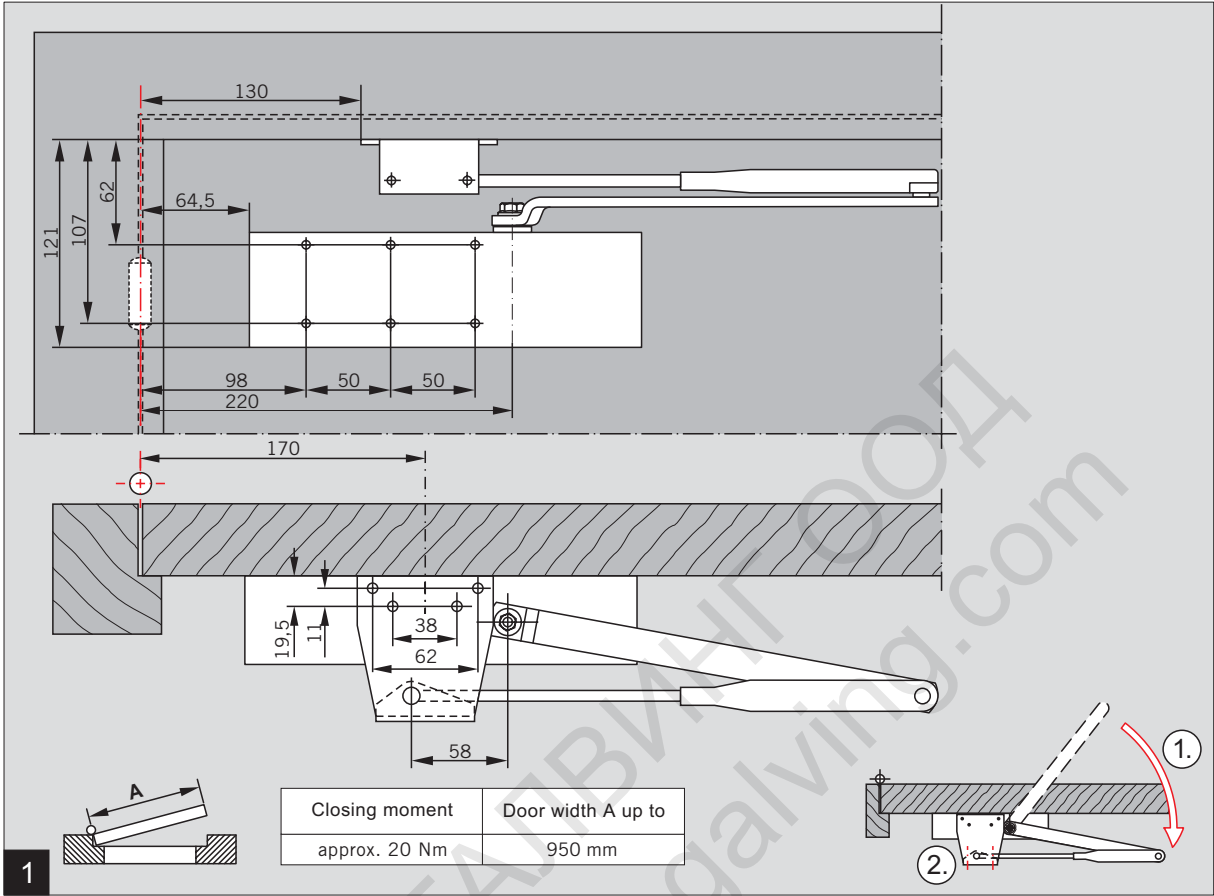

Änderungen vorbehalten

